

Torpedo Reload User's Manual

Guitar Connectivity... Perfected!



The complete electronic version of this manual, as well as the Two notes Audio Engineering software and hardware products, are subject to updates. You can download the most recent versions of the products on the [Two notes Audio Engineering](http://www.two-notes.com) website.

This manual describes the Torpedo Reload and provides instructions for its operation. It is highly recommended that you read this document before using the product. The contents of this manual have been thoroughly verified and it is believed, unless stated otherwise, to accurately describe the product at the time of shipment from the factory or download from our website.

Two notes Audio Engineering is a registered trademark of:

OROSYS SAS
76 rue de la Mine
34980 Saint-Gély-du-Fesc
France
Tel: +33 (0)484 250 910
Fax: +33 (0)467 595 703
Contact and support: <http://support.two-notes.com>
Website: <http://www.two-notes.com>

This document is the exclusive property of OROSYS SAS. In the interest of product development, OROSYS SAS reserves the right to change technical specifications, modify and/or cease production without prior notice. OROSYS SAS cannot be held responsible for any damage, accidental or otherwise, that results from an inappropriate use of the Torpedo Reload. Please refer to the safety instructions included in this manual. The reproduction of any part of this document is strictly forbidden without the written authorization of OROSYS SAS.

All product names and trademarks are the property of their respective owners. Product names and trademarks found in this document were used during the development of the Torpedo Reload product but are in no way associated or affiliated with OROSYS SAS.

1. Foreword

1.1 Safety instructions

Before using the product, it is necessary to carefully read and to bear in mind the following information. **Keep this document in a safe place as it is important for the protection of both user and product.** Should you suspect any malfunction of the device, always seek the assistance of a qualified technician.

1.1.1 Risk of electric shock



The triangle with a lightning bolt means that some parts of the product, even when the power is turned off or unplugged, can retain voltage high enough to cause serious electric shock. Any operation that requires opening the device should be left to a qualified technician.

1.1.2 Reader warning



The triangle with an exclamation mark highlights important messages concerning the correct use of the device.

1.1.3 Mains Power

Please verify that the voltage required by the device matches the voltage of your country. If it doesn't or if you are unsure, do not plug the device to the wall outlet as this could result in damage to the device and injuries to the user.

This product must not be used during lightning storms. In case of severe weather with a risk of lightning, unplug the mains power supply to reduce the risk of electric shock and fire.

The mains power cable provided with the unit complies with the standards of the country where you purchased the product. If replacement is needed, please use a standard compliant cable.

1.1.4 Ground Connection

For safety reasons, the unit needs to be plugged into a wall outlet with a ground connection. If your electric installation does not provide a ground connection or if you are unsure, please ask a qualified electrician for help. If your mains power cable does not match your wall outlet, ask a qualified electrician for help. In order to prevent risks of electric shock or fire, never remove the outer or inner ground connection of the unit.

1.1.5 Safety use conditions

The Torpedo Reload must never be used near a heat source, near a flame, in the rain, in damp areas, near any kinds of liquids.

When transporting the unit, care needs to be taken to avoid any shocks that might cause damage and therefore require the assistance of a qualified technician.

Never cover or restrict the ventilation openings. Never unplug or deactivate the heat control monitoring system, or you will be exposed to risks of electric shock and fire.

1.1.6 Cleaning

Always use a piece of dry and soft cloth with no alcohol or solvents for cleaning. Please keep the unit clean and free from dust.

1.1.7 Maintenance

All maintenance operations must be performed by service centers approved by OROSYS SAS or by qualified technicians. Never try to repair the machine by yourself.

1.2 Contents of the package

The shipped package contains:

- One Torpedo Reload unit in a protective sleeve
- One mains power cable
- One User's Manual

The complete electronic version of this manual, as well as the Torpedo Remote and Torpedo BlendIR softwares are subject to updates. You can download the most recent versions of these products on the [Two notes Audio Engineering](http://wiki.two-notes.com/) website.

1.3 Declaration of conformity

Manufacturer: OROSYS SAS

Category of product: digital audio signal processor

Product: Torpedo Reload

Test Manager: Guillaume Pille

The Two notes Torpedo Reload is certified to be compliant to the CE and FCC standards:

- EN 55103-1 : 1996 and EN 55103-2 : 1996.
- EN 60065 05/2002 + A1 05/2006.
- EMC directive 89/336/EEC and Low Voltage Directive 73/23/EEC.
- FCC Part 15 : 2008.
- ICES-003 : 2004.
- AS/NZS 3548 class B for Australia and New Zealand.
- IEC : 2008 - CISPR 22 class B.



1.4 Disposal of Waste Equipment by Users in Private Household in the European Union



This symbol on the product or on its packaging indicates that this product must not be disposed of with your other household waste. Instead, it is your responsibility to dispose of your waste equipment by handing it over to a designated collection point for the recycling of waste electrical and electronic equipment. The separate collection and recycling of your waste equipment at the time of disposal will help to conserve natural resources and ensure that it is recycled in a manner that protects human health and the environment. For more information about where you can drop off your waste equipment for recycling, please contact your local city office, your household waste disposal service or the shop where you purchased the product.

1.5 Warranty

OROSYS SARL warrants that this TWO NOTES AUDIO ENGINEERING product shall be free of defects in parts and workmanship when used under normal operating conditions for a period of two (2) years from the date of purchase. This warranty shall apply to the original purchaser when purchased from an Authorized TWO NOTES AUDIO ENGINEERING dealer.

IMPORTANT: PLEASE RETAIN YOUR SALES RECEIPT, AS IT IS YOUR PROOF OF PURCHASE COVERING YOUR LIMITED WARRANTY. THIS LIMITED WARRANTY IS VOID WITHOUT YOUR SALES RECEIPT.

Defective products that qualify for coverage under this warranty will be repaired or replaced, (at OROSYS SAS's sole discretion) with a like or comparable product, without charge. In the event that warranty service be required, Please contact your authorized TWO NOTES AUDIO ENGINEERING dealer in order to obtain an RMA to return the complete product to the Authorized TWO NOTES AUDIO ENGINEERING Service Center closest to you, with proof of purchase, during the applicable warranty period.

Transportation costs to the service center ARE NOT INCLUDED in this limited warranty. OROSYS SAS will cover the cost of standard ground return transportation for repairs performed under this warranty.

This limited warranty becomes void if the serial number on the product is defaced or removed, or if the product has been damaged by alteration, misuse including connection to faulty or unsuitable ancillary equipment, accident including lightning, water, fire, or neglect; or if repair has been attempted by persons not authorized by OROSYS SAS.

Any implied warranties, including without limitation, any implied warranties of merchantability or fitness for any particular purpose, imposed under state or provincial law are limited to the duration of this limited warranty. Some states or provinces do not allow limitations on how long an implied warranty lasts, so the above limitations may not be applicable.

OROSYS SAS ASSUMES NO LIABILITY FOR PROPERTY DAMAGE RESULTING FROM ANY FAILURE OF THIS PRODUCT NOR ANY LOSS OF INCOME, SATISFACTION, OR DAMAGES ARISING FROM THE LOSS OF USE OF SAME DUE TO DEFECTS OR AVAILABILITY OF IT DURING SERVICE.

In case you must absolutely send your TWO NOTES AUDIO ENGINEERING product to any other location, it is of vital importance that you keep the original packing material. It is very difficult to avoid damage when shipping the product without that material. OROSYS SAS is not responsible for damages caused to the product by improper packaging and reserves the right to charge a reboxing fee for any unit returned for service without the original packing material.

THE FOREGOING CONSTITUTES THE ONLY WARRANTY MADE BY OROSYS SAS WITH RESPECT TO THE PRODUCTS AND IS MADE EXPRESSLY IN LIEU OF ALL OTHER WARRANTIES EXPRESSED OR IMPLIED.

2. Recommendation on the proper use of a loadbox with a tube amplifier

2.1 What is a loadbox?

In the normal use of a tube amplifier, it is highly recommended that you always connect its power output to a speaker cabinet prior to powering it up. The speaker cabinet (4, 8 or 16 Ohms) must always be connected to the corresponding speaker output of your amplifier. Not doing so can lead to partial or complete destruction of the output stage of the tube amplifier.

Most tube amplifiers makers protect their products with fuses or other protection systems, however

some amplifiers are still insufficiently protected. It is impossible to predict the behavior of all the amplifiers on the market in case of use without a load (a speaker cabinet or a loadbox).

The electronic term that describes the speaker cabinet with respect to the amplifier is the “load”: we say the cabinet “loads” the amplifier. The term “loadbox” is used to describe any product that provides a load to the amplifier. The main parameter of the loadbox is its impedance, expressed in Ohms. An 8-Ohm loadbox must be plugged to the 8-Ohm speaker output of the amplifier.

The power sent to the load is turned into heat, so please follow the cooling recommendation in the manual — otherwise overheating may cause damage, both to the loadbox and to the amplifier.

The Torpedo Reload is a loadbox. This term indicates that the Torpedo Reload is a load which can electrically replace the speaker cabinet while dissipating (transforming into heat) the power coming out of the amplifier.

Within the Torpedo Reload is a Reactive load. A Reactive load simulates the complex impedance of a real speaker.



Always connect the speaker out of your tube amplifier to an appropriate load (speaker cabinet or loadbox). The Torpedo Reload, once powered up, is such a load. Please note that you should always power up the Torpedo Reload before your amplifier. The maximum admissible power of the Torpedo Reload is 150W RMS, your amplifier shouldn't be set to play at a higher output power value. See [this article](#) if your amplifier is more powerful than 150W.

2.2 Which output volume for my amplifier?

The correct use of your amplifier with a loadbox requires some precautions. Because of the silence while playing, it is much easier to accidentally run your amplifier beyond the reasonable limits set by the manufacturer than when using a real speaker cabinet with it. This can lead to faster tube wear and, in some cases, to more serious inconveniences.



When first testing the amplifier at high volume, monitor the color of the tubes and the general state of the amplifier. Red-glowing tubes or any appearance of smoke are signs of a problem that may result in partial or complete destruction of the amplifier.

Keep in mind that the “sweet spot” - the perfect running point of the amplifier, the one that will give you the tone you’re looking for - is rarely obtained at maximum volume. In addition, the volume control of the amplifier is usually logarithmic, which means the volume goes up quickly on the first half of the potentiometer rotation, reaches its maximum at 12 o’clock, and doesn’t change much beyond this point. Therefore, you can reach the maximum volume of your amplifier even if the volume potentiometer is not set at maximum.

By reaching the maximum output power of your amplifier, you will hear a lot of distortion, which may not sound as well as you may hope. In fact, most amplifiers sound rather poorly at maximum volume. Always keep in mind that your amplifier may not have been conceived to be used at maximum volume for a long period of time. Running an amplifier at high volume will cause premature wear of

the tubes and possible malfunctions or damages at the output stage.



The fact that the volume control of your amplifier is not set at maximum doesn't mean your amplifier is not running at maximum volume. A good habit is to keep the usual volume setup you would use in rehearsal or on stage, rather than just following what the volume potentiometer indicates.

2.3 Is the use of a loadbox totally silent?

We usually talk about “silent recording” when a loadbox is involved. If we compare the loadbox solution to a traditional cabinet miking solution, it is obviously A LOT quieter. Noises that you may have not been able to hear before due to the volume of the speaker cabinet will now be more apparent. Here are a few of those sounds that you might have to take into account:

- Your guitar or bass strings can be heard. If you are not used to this, it could be initially distracting, depending on your environment.
- You may hear some noise coming out of your Torpedo Reload when playing, like there is a tiny speaker inside the box. This is perfectly normal and there is no reason to worry. The sound is produced when power goes through the coil of the reactive load embedded on the Torpedo Reload. The vibration is related to what power comes out of the amplifier connected to the Torpedo Reload and to the signal's frequency content (notes played are heard). Your amplifier, specifically the output transformer of your amplifier, may also produce similar noise. Such noise is usually not heard, simply because it is normally obscured by the sound coming from the loudspeaker.
- The Torpedo Reload has a built in fan, as there is quite a lot of power dissipated into heat inside the box. We selected a so called “silent fan”, but as it is running fast, it is never entirely silent. This said, you can consider that, in normal use (hearing your guitar through monitors, or headphones), you can barely hear the fan.

3. About the Torpedo Reload

3.1 Introducing the Torpedo Reload

Two notes Audio Engineering is proud to introduce the Torpedo Reload, the all-in-one analog interface for recording guitars and basses in the studio. This product has been developed through several years of technical development, with great attention paid to the needs of guitarists, bassists and sound technicians faced with the challenges posed by the miking of instrument amplifiers, on stage or in the studio. Our goal is to provide ease of use, reliability, versatility and above all, perfect audio quality.

The Torpedo Reload is the interface everyone involved in modern guitar and bass recording situations needs. It was designed at first as the perfect interface between a guitar or bass amplifier and a sound card, so you can send the best signal possible to our **Torpedo Wall of Sound** plug-in, which embeds the Torpedo technology.

Recording your guitar or bass amplifier in silence has always been the purpose of the Torpedo products, but with the Torpedo Reload Two notes has striven to gather together all of the major functions and products you may need in a recording room:

- A **Hi-Z instrument DI** so you can record you guitar's signal directly;
- The most transparent **power attenuator** and **loadbox** with multi-impedance input and continuous volume setting, from a minimal attenuation to 0dB. Two notes creates the **RE-ACT™** technology;
- A **re-amplifying interface** with a special function to perfectly adjust the level sent from the audio interface to the amplifier. Two notes creates the **REPLAY™** and **MATCH™** functions.

Record your guitar using the DI, send the signal back to your amp using REPLAY™, drive your amplifier the way it should be driven and lower the level or simply make it silent with RE-ACT™, record the signal from the load box, and even use your own microphones and cabinets for a 3rd take - all simultaneously if needed!

This product has been thoroughly tested in professional studio and stage environments and is the alternative many musicians have been waiting for to professionally capture the sounds of their amplified instruments. The Torpedo Reload coupled with Torpedo Wall of Sound will bring you the elusive sound of the greatest recording studios and producers, anytime, anywhere.

3.2 Front panel



- | | | | |
|-----------------------------|-------------------------|------------------------------|---------------------------|
| 1. Mains switch | 4. Loadbox output level | 7. Ventilation slit | 10. MATCH™ indicators |
| 2. Hi-Z DI instrument input | 5. Speaker output level | 8. Signal indicators | 11. Overheating indicator |
| 3. REPLAY™ level | 6. Contour | 9. Load impedance indicators | |

3.3 Rear panel



- | | |
|----------------------------|-------------------|
| 1. Fan | 4. Loadbox output |
| 2. RE-ACT™ speaker input | 5. DI output |
| 3. RE-ACT™ speaker outputs | 6. REPLAY™ I/Os |

3.4 The Torpedo Reload's advanced functions

3.4.1 RE-ACT™



Attenuators are usually known for the negative impact they have on your tone in cases of heavy attenuation, which is mainly due to the fact that the load presented to the amplifier will vary depending on the attenuation level. On the contrary, the Reactive-Active technology (RE-ACT™) presents your amplifier with a consistent speaker's impedance no matter what level of attenuation you are at, thus preserving the specific character of your amplifier.

With a choice of 4, 8, or 16 Ohms, your amplifier (up to 150W RMS, 200W peak) will actually see real speaker impedance, and your tone will remain constant throughout the continuous attenuation curve.

The attenuated outputs and the loadbox output can be used at the same time, so you can simultaneously record the dry output from your amplifier's speaker output and perform a traditional miking of your cabinet(s). You can plug or unplug the speaker cabinet anytime without worrying about its impedance with regards to the amplifier's speaker output impedance, as the two are totally independent.

Another issue with amplifier attenuation has to do with how our ears perceive the sound. In effect, the lower the volume of the sound is, the less we hear low and high frequencies. That is because our hearing is way better at low volumes for the mid frequencies of the voice, for example. The CONTOUR parameter can be seen as a loudness compensation effect, but it can also be used as a creative effect. Turn the button to the left (Vintage) and you will get a rich, medium-centered tone with a lot of presence. Turn CONTOUR to the right (Modern) and you will get more bass and treble, a V-shaped tone to get those frequencies your ears cannot perceive at low volume. Or simply to get that ultra-tight metal tone or ultra-warm clean tone you are looking for...

Please note that a minimal attenuation is applied to the input power amplifier signal, whatever the position of the SPEAKER potentiometer. There is no bypass mode in the Torpedo Reload, meaning the sound will always be attenuated at the Torpedo Reload SPEAKER output. This attenuation is a function of several parameters, read more about that in the [Specifications](#) section.

3.4.2 Hi-Z instrument DI

Plug your guitar or bass into the DI input and send that signal to your microphone preamplifier connected to your recorder. If the DI signal is too strong for your preamplifier, you can connect the DI output to a Line input, by using an XLR-XLR cable or XLR (female) to Jack 6.35mm (1/4") TRS. At that stage what you want is clarity and Two notes preserves your guitar's tone, as you will certainly want to re-inject it into your amp through the REPLAY™.

This DI signal is also suitable to feed any kind of amplifier-modeling software that can be followed by the Torpedo Wall of Sound plug-in.

Please note that here is no hardwired splitter function in the Torpedo Reload. To feed at the same time your DAW and an amplifier, you will need to send back the signal from the DAW using the REPLAY™ interface. Please read about the REPLAY™ function to discover this new and very effective way to record your instrument.

3.4.3 REPLAY™



One of the most interesting options in studios nowadays: play the guitar one day, and mike the amplifier (or many different amps) another. The Torpedo Reload is your re-amplifying device of choice.

The REPLAY™ output follows a low-impedance unbalanced design to ensure the best conditions when sending the signal to the amplifier. The ground lifts will allow you to solve any grounding issues that may come up when you are setting up the kind of complex wiring you can use with the Torpedo Reload.

The most difficult part in re-amplification techniques is finding the output level on the DAW (Digital AudioWorkstation) that matches the level of your guitar when it is directly connected to the amplifier. This problem is now solved, thanks to the Torpedo Reload's unique MATCH™ feature.

3.4.4 MATCH™



This Two notes innovation is the solution to the problem of level adjustment when re-amplifying. If the level is too high your amplifier will tend to over-saturate, if the level is too weak the tone will lack dynamics and liveliness.

MATCH™ compares the signal as it comes from the guitar (plugged to the DI input) with the signal that has been recorded (and which is sent to the REPLAY™ Line Input) so that what you send the amp is the ideal level only. Now you can be sure that the signal you send from the DAW is exactly what your guitar itself would be sending.

You may even perform a MATCH™ with two different signals: if you have a previously recorded track, for instance, but do not have the guitar with you — plug a similar guitar into the DI In and match it to the signal!

3.5 The Torpedo technology and Torpedo Wall of Sound



The Torpedo technology was created as an answer to the high pressure musicians have to deal with: lack of time, limited gear availability, loud amplifiers that cannot be played at desired volume, as well as bulky and heavy cabinets to carry. In addition, many musicians are more comfortable with their analog amplifier and effect pedals, and feel reluctant to perform using digital modeling systems that might compromise their playing style and sound.

The Torpedo Technology: for unsurpassed realism and playing comfort, Two notes has developed a

unique technology based on an adaptation of convolution techniques. Starting with the measurement of an actual cabinet + microphone setup, Torpedo Wall of Sound can accurately **reproduce the system as it was measured**, as well as the **microphone's position in space**.

The Torpedo Reload comes with a Torpedo Wall of Sound plugin license. Torpedo Wall of Sound offers a “virtual” alternative to traditional miking to achieve a degree of realism never experienced previously with simulators. The musician simply plugs the Torpedo Reload in place of his/her cabinet, connecting the amplifier's speaker output to it and without modifying any of his/her usual settings (or connected effect pedals as applicable). From there, the Torpedo Reload Loadbox output signal can be sent to any microphone preamplifier and that signal recorded thanks to your DAW on a track embedding the Torpedo Wall of Sound plugin.

The Torpedo Reload comes with a library of 24 cabinets and 8 microphones among the most commonly used models in the world, which you can use in Wall of Sound. You can also upgrade and add many other cabinets through “La Boutique”, our online virtual cabinet store. The virtual miking is done by choosing one cabinet and one microphone, then fine-tuning the position of the microphone in front of the cabinet. Wall of Sound thus enables the user to assume the role of the sound engineer in a professional studio.

3.6 Torpedo Wall of Sound, only A Speaker Simulator?

The Torpedo Wall of Sound is a software plug-in you can embed in your recording program. The plugin should be used on tracks containing guitar or bass signal recorded from a preamplifier (guitar, bass, or any product with a line output) — or from a loadbox like the Torpedo Reload if you want to record the signal coming from the speaker output of your amp.

The role of Wall of Sound is to replace the following elements of the traditional guitar or bass setup:

- the guitar/bass power amplifier
- the speaker cabinet
- the microphone
- the microphone preamplifier

In order to provide a signal that is the closest possible to a traditional guitar/bass miking in a professional studio environment.

The miking is achieved in 3 steps in Wall of Sound :

1. Choose a power amplifier (or switch it off if you are using a loadbox), a speaker cabinet and a microphone (Gear menu)
2. Position the microphone inside the virtual studio (Miking menu)
3. Shape the signal (Post-FX menu).

At each step, Two notes Audio Engineering implements its know-how to offer the most advanced simulations on the market and ensure absolutely realistic quality both for the musician (in terms of playing sensation) and for the listener (in terms of sound quality).

Note: the evaluation version of Torpedo Wall of Sound is limited to 8 microphones and 2 cabinets, but the Torpedo Reload comes with a full license of Wall of Sound, offering 24

cabinets.

3.6.1 Tube Stage Output

When using guitar/bass preamplifiers with some other speaker emulators, the musician may feel they miss a **power amplifier's** contribution to the overall sonic texture. Many musicians get their sound from a particular use of that element and Torpedo Wall of Sound gives you the possibility to use it too.

To that effect, Two notes Audio Engineering has developed an original tube-stage modeling that gives you a choice of 4 different tube models (6L6, EL34, EL84 and KT88) in Push-Pull (PP) in AB class, or Single Ended (SE) in A class configurations. You can push this tube stage like a conventional amplifier and look for that subtle yet particular distortion.

Torpedo Wall of Sound can be used as a super-DI for keyboards. The tube-amp simulation feature, developed for guitarists and bassists, can also be a very interesting device to warm up the sound of a synthesizer, an organ, or a digital piano.

3.6.2 The Torpedo technology, convolution and Impulse Responses

The Impulse Response (IR) of a given system consists in the description of that system's behavior in the form of a very detailed filter. The convolution technique uses IRs to simulate the behavior of specific systems such as reverbs, speakers, EQ, and so on.

This is the most accurate method to simulate sound signatures that are linear (i.e. without distortion) and time-invariant (i.e. with no effect such as modulation, compression, hysteresis, etc.). It is particularly well suited for speaker miking simulation.

Two notes has developed a unique technology based on an adaptation of convolution techniques. Starting with a measure of a real cabinet + microphone setup, Torpedo Wall of Sound can accurately reproduce the system as it was measured, including its distortion, as well as the microphone's position in space by using IR synthesis. Control the amount of distortion produced in the loudspeakers (Overload) and fix any phase issue with the Variphi – exclusive Two notes Virtual Cabinets functions.

3.6.3 Multi miking

Torpedo Wall of Sound offers you what every sound engineer wants: the possibility of carefully placing several microphones before the same cabinet, or of selecting several different cabinets and microphones and mixing them.

You will discover the unlimited possibilities of multi miking, with up to 100 processing channels! Add as many microphone and cabinet configurations and mix them in the stereo field or keep them isolated on each channel, in real time.

3.6.4 Post FX Section

When recording guitars or basses, it is common to apply a few effects to shape the sound before it is sent to a PA or a recorder. In Torpedo Wall of Sound, you will find a 6-bands EQ filter (with guitar, bass

and parametric modes), a 2-bands exciter, a studio compressor and a tweakable reverb.

3.6.5 3rd Party Impulse Responses

Torpedo Wall of Sound is capable of delivering the best guitar and bass tones by using the Torpedo technology, but you can also embed impulse responses that you have purchased or downloaded for free from 3rd-party developers, in WAV or AIFF formats.

3.6.6 Create Your Own IR's

Download the free Torpedo BlendIR software from the [Two notes Audio Engineering](http://www.two-notes.com) website. With this software you will be able to capture your own cabinet + microphone setup and embed its sound signature into Torpedo Wall of Sound.

4. Connecting the Torpedo Reload

4.1 Overview

The Torpedo Reload offers a solution for silent and quality sound pick-up in many situations. The following illustrations show the most common situations the Torpedo Reload has been created for.





1. Guitar/Bass

4. Guitar/bass speaker

6. Audio interface

- | | | |
|---------------------------|--------------------|-----------------------------|
| 2. Torpedo Reload (front) | cabinets | 7. PC/Mac with Torpedo Wall |
| 3. Torpedo Reload (rear) | 5. Guitar/Bass amp | of Sound |

All functions work at the same time, but we will first show a variety of the more simple setups.

	Please keep in mind that tube amplifiers must be connected to an appropriate load (cabinet or loadbox). Always plug the speaker output from your amp to the speaker input of the Torpedo Reload, and select the matching impedance.
	Always use a standard speaker cable between the amplifier speaker out and the Torpedo Reload SPKR IN. A speaker cable and an instrument cable may look similar. You may have to open the jack connector and see for yourself: the speaker cable is unshielded and carries the powerful signal through two insulated conductors, the instrument cable is shielded and has only one internal conductor. Using an instrument cable instead of a speaker cable can cause significant damage to your amplifier, requiring service by a technician.

4.2 LED indicators

You will find different LED indicators on the Torpedo Reload front panel:



- **SIGNAL / CLIP:** indicates the presence of a signal in either the DI, REPLAY™ or SPEAKER input (green color). The LED lights up red whenever that signal is too strong — if so, you need to lower the volume at the corresponding input.
- **MATCH™:** Increase the REPLAY™ potentiometer value if the up arrow lights up, and lower the value if the down arrow lights up. “OK” means that the level of the signal sent to the amplifier through the REPLAY™ Amp Out and that of the guitar’s signal in the DI input are at matching volumes.
- **LOAD IMPEDANCE:** shows the selected impedance on the Torpedo Reload. This value must match the value of your amplifier’s speaker output. Go to the back of the Torpedo Reload and select either 4, 8 or 16 Ohms.

NB: The Torpedo Reload must be turned off when you select the SPEAKER input impedance. Your amplifier should not be powered on during the process.

- **Overheating warning:** this last indicator will light up if the temperature inside the Torpedo Reload is too high, which activates the security load. If so, please lower the volume on your amplifier or stop playing for some time, so the temperature decreases.

4.3 DI recording

This first setup is what you will use when you want to connect your instrument to your sound card properly to do some recording and/or to feed an amp-modeler plugin. The Hi-Z (High Impedance) instrument input of the Torpedo Reload will handle your guitar or bass signal so you face no loss of dynamic or frequency:

1. Plug your guitar to the DI input and the DI output to your microphone preamplifier (or channel 1 on the mixer, or embedded preamplifier on your audio interface), and that preamplifier to Line channel input 1 on your audio interface.
2. Activate Track 1 for recording & live monitoring, select channel 1 as an input.
3. Start recording!



In any setup that involves a microphone preamplifier, it is important to set the correct gain on the preamplifier so the level of the recorded track is high enough. It is commonly recommended to set the gain on the preamplifier so the instrument's signal will hit -16dB FS to -18dB FS (i.e., dB Full Scale, the value indicated on your sound card and sequencer input meter).



If the DI output signal is too high for your microphone preamplifier input, and your preamplifier doesn't provide a PAD attenuator, consider using a line input instead. You may have to use an XLR Female Plug 3-pin to TRS 6.35mm (1/4") Jack cable if your soundcard/mixer only provides Jack line input(s).

4.4 Power attenuator and load box

4.4.1 RE-ACT™, how does it work?

Some attenuators are resistive, others are reactive, and most of them are passive.

Passive means that the attenuator's electronics does not require a power supply.

Resistive means that the power out of your amplifier is tamed by the presence of one or several resistors on the signal path. The load impedance plays a huge role on the sound, and a resistive attenuator will make the tone somewhat darker, with losses in the high and low frequencies.

Reactive means that reactive elements (transformers, coils and/or capacitors) are used instead of mere resistors. With this technology, the damping factor will decrease with the level of attenuation. Most of the time, a reactive attenuator means losses in character and fidelity, "muddy" sound and other unwanted effects.

Another downside of passive resistive/reactive attenuator is the way the listening level is controlled, usually by some stepped potentiometer, which does not allow for precise volume setting, and limits you to a set of fixed attenuations.

RE-ACT™ stands for "**Reactive-Active Attenuator**", which means it uses a **reactive load** and **active** overall schematics. In effect, the RE-ACT™ can be described as the conjunction of two elements:

- a reactive loadbox inherited from the critically acclaimed Torpedo Live series, followed by
- an ultra-low-distorsion, wideband, low-noise solid-state amplifier based on a widely used HiFi architecture.

The role of this system is to present a speaker-like impedance to your amplifier, get rid of the power, then re-amplify it to the desired volume. This design offers a number of advantages over resistive/passive ones:

- the amp is always connected to a fixed impedance, which is as close as possible to a real speaker impedance;
- as the impedance does not change with the attenuation, the tone of your amp stays the same;
- the volume you hear in the room can be set continuously, you get REAL master-volume control (SPEAKER parameter), after your amplifier's master volume;
- the speaker-output impedance of your amplifier is independent from the speaker impedance of the actual speaker cabinet you plug on the Torpedo Reload. This opens up a great many fun possibilities of cabinet mixing.

4.4.2 Connection

Connecting the Reload as an attenuator is really quite simple, provided you observe the following:

- Always match the value of the impedance on the Torpedo Reload (either 4, 8 or 16 Ohms) to your amplifier's speaker-output impedance.
- The Torpedo Reload will normally get warm during use, so you must not put it in a closed box or obstruct the air vents.
- You can connect one or two cabinets to the Torpedo Reload, or no cabinet at all if you want to use the loadbox only (silent playing and recording).
- The impedance of the cabinets you may plug to your amp is independent from the impedance of that amplifier. You can very well use the 8-Ohm speaker output of your amp while having one 8-Ohm cabinet and another 16-Ohm cabinet plugged to the Torpedo Reload! Please refer to "Possible post-attenuation speaker combinations", Part 7.2.3 for more information about cabinet matching.



1. Connect your amplifier's speaker out to the Torpedo Reload's SPEAKER IN.
2. Make sure the impedance selected on the Torpedo Reload matches the value at your amp's output.
3. Connect a cabinet to the lower SPEAKER OUT jack.
4. Connect a second cabinet, if needed, to the higher SPEAKER OUT jack.

	<p>The loadbox inside the Torpedo Reload remains active whether you have plugged a cabinet to it or not. We recommend using amplifiers with a maximum power rating of 150W RMS (200W peak). Basically, the loadbox turns your amplifier's power into heat. If the temperature inside the Torpedo Reload is too high due to an excess of power, DO NOT WORRY: the active security system will put your amp on a safe security load, while the Torpedo Reload cools down.</p>
	<p>When you play your amplifier loud, you may hear some noise coming out of the Torpedo Reload. This is perfectly normal and there is no reason to worry. The sound is produced when power goes through the coil of the reactive load embedded in the Torpedo Reload. The vibration is related to what power comes out of the amplifier connected to the Torpedo Reload and to the signal's frequency content (i.e., notes played are heard). Your amplifier may also produce similar noise, at the output transformer's stage. Such noise is usually not heard, simply because it is normally covered by the sound coming from the loudspeaker.</p>
	<p>The sound may be a little different depending on whether a Torpedo Reload is placed between your amplifier and your cabinet or not. That is normal, as the internal speaker impedance of the Torpedo Reload will be slightly different from your cabinet's. Most importantly, this slight difference is constant and does not depend on the attenuation level.</p>

4.4.3 Contour



The CONTOUR parameter will help you find the tone you are searching for, at low volume. This filter changes the attenuated speaker output, from more medium and vintage tones to more modern and midscooped tones. Basically, when playing at low volume, you may want to add that missing bass and treble, but we like to imagine a more creative way of using the CONTOUR, by modifying the tonal characteristics of your amplifier during a recording through traditional miking.

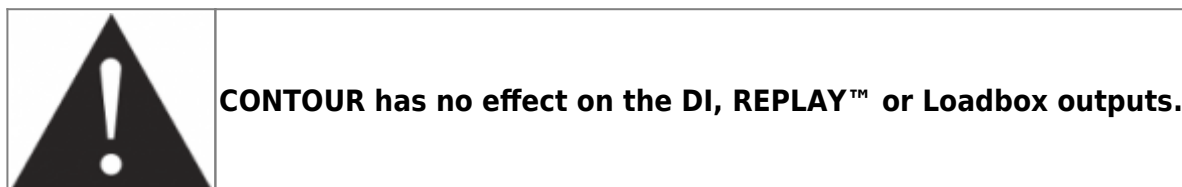

4.5 Re-amplification using REPLAY™

Re-amplification techniques are commonly used nowadays, mainly to let the guitarist record a dry guitar in one place and time, and then have that dry recording sent to one or many amplifiers by a sound engineer who will take the time to find the right combination for the song. This way a guitar player who is equipped with a good quality DI and a DAW can take the time to quietly record at home without travelling to a studio, and eventually get a pro recording of a real amplifier. For more information about re-amping techniques, please read this Wikipedia article:

<http://en.wikipedia.org/wiki/Re-amp>.

With the Torpedo Reload, you can do both of those things: record the dry guitar with the DI, and then use the REPLAY™ to send that guitar track back to an amplifier. We will here present first a silent REPLAY™ (i.e., without actual cabinets plugged to the Torpedo Reload), and then the full setup for recording 3 different tracks at the same time.



4.5.1 Silent REPLAY™

We shall assume here that the DI setup presented above (“3 Di recording”) is already operational. On track 1 of your sequencer you have recorded the sound sample of a dry guitar signal.

1. Route Track 1 so its output is sent to your audio interface’s output 3, if 1 & 2 are used as Master output. It is important you use a different output from the Master one. This way you can hear the replayed track on the Master output, while sending the dry track to another output. If you only have 2 outputs, you can use output 1 to send track 1 and output 2 to hear the newly recorded replayed signal.
2. Connect the interface’s output 3 into the REPLAY™ input.
3. Connect the REPLAY™ output to your amplifier’s input.
4. Connect your amplifier’s output to the Torpedo Reload’s speaker input.
5. Connect the Torpedo Reload’s Loadbox to your second microphone preamplifier (or channel 2 of the mixer, preamp 2 on the audio interface).
6. Connect the preamplifier to the Line channel input 2 on your audio interface.
7. Activate Track 2 for recording & live monitoring, select channel 2 as an input
8. You can insert Torpedo Wall of Sound on the track so you can perform (non-destructive) miking while recording the dry signal of the amplifier.
9. Start recording!

4.5.2 The full setup: DI + LOADBOX + miking

In the previous setup we decided to achieve a silent REPLAY™, but you can perform some traditional miking at the same time, with a controlled sound level thanks to the Torpedo Reload’s power attenuator.

1. Connect a cabinet to the Torpedo Reload’s speaker output, set the appropriate volume for the cabinet using the SPEAKER potentiometer. Plug a microphone to your third preamplifier

- (channel 3 on the mixer, etc.), place the microphone in front of the cabinet.
- 2. Connect the preamplifier to the Line channel input 3 on your audio interface.
- 3. Activate Track 3 for recording and eventually live monitoring to hear the result in the Master, select channel 3 as an input.
- 4. Record!



When replaying with a high-gain amplifier, you may experience some unwanted noises, at a level higher than what you were used to with a guitar directly plugged into the amp. This is normal and mainly due to the amp's huge level of gain, whereas our setup here is more complex and more sensitive to every source of noise in it. The different ground lifts we add to the Torpedo Reload will help, but may not be enough. We recommend having the different products (instrument, Torpedo Reload, computer, amplifier) as far as possible from one another, while keeping the unbalanced connections as short as possible. A noise gate in the effects loop of the amplifier always helps a lot with this kind of issue.

4.5.3 MATCH™

The unique MATCH™ function will compare the signal sent from the guitar with the signal coming back from the audio interface. Use the REPLAY™ potentiometer to adjust the level of the track's signal.



We shall assume here that the silent REPLAY™ setup is operative. Activate the track-1 monitoring so the guitar's dry sound will come back to the audio interface into the REPLAY™ input. That way the Torpedo Reload will be able to compare the guitar's signal with the one sent by the audio interface.



Play the guitar so you see a LED on the MATCH™ panel light up. Increase or decrease the value of the REPLAY™ potentiometer until the OK green led lights up, and your level-matching is done!



MATCH™ works best if the latency of your digital audio interface is set to a value inferior to 20 milliseconds.

4.5.4 MATCH™ without the original guitar

You cannot use the MATCH™ function because your are replaying tracks that were recorded at a different time and place? Try to get some information about the guitar/bass that was used. Find a guitar with similar pickups (single coils, humbuckers, active...) and use MATCH™ as if this were the guitar used during the initial guitar recording, to find the REPLAY™ potentiometer's correct value.

5. Specifications

5.1 List of Power Amplifiers (available through Wall of Sound)

Designation	Characteristics
SE 6L6	Configuration Single Ended - Class A with 6L6
SE EL34	Configuration Single Ended - Class A with EL34
SE EL84	Configuration Single Ended - Class A with EL84
SE KT88	Configuration Single Ended - Class A with KT88
PP 6L6	Configuration Push-Pull - Class AB with 6L6
PP EL34	Configuration Push-Pull - Class AB with EL34
PP EL84	Configuration Push-Pull - Class AB with EL84
PP KT88	Configuration Push-Pull - Class AB with KT88

5.2 List of Cabinets (available through Wall of Sound)

Designation	Inspired by
GUITAR cabinets	
2Notes CSG	Two Notes Custom 1×12" ElectroVoice® EVM12L
Angl VintC	Engl® 4×12" Celestion® V30
Blonde 63	Fender® Bassman '63 Blonde Tolex Piggy Back 2×12"
Brit 65C	Marshall® 1965A 4×10" Celestion® G10L-35 close back
Brit VintC	Marshall® Slash Signature 4×12" Celestion® V30 close back
Calif StdC	Mesa/Boogie® Rectifier® Standard 4×12" Celestion® V30 close back
Eddie	Peavey® 5150 2×12" Sheffield 1200
Free Rock2	VHT® Deliverance 2×12" Eminence® P50E
Green Tri	Hughes&Kettner® Triamp 4×12" Celestion® Greenback
Jazz 120	Vintage Roland® JC120 2×12"
JubilGreen	Marshall® 2550 2×12" Celestion® Greenback
Kerozen	Diezel® 4×12" Celestion® V30
Silver77	Vintage Fender® Twin Reverb® 2×12" orange JBL®
SilverJen	Vintage Fender® Twin Reverb® 2×12" Jensen® C12K
The One	Brunetti® Neo1512 1×15" + 1×12"
Vibro Utah	Vintage 1961 Fender® Vibrolux® 1×12" original Utah speaker
BASS cabinets	
2Notes CSB	Two Notes Custom 1×15"
Alu XL	Hartke® XL 4×12"
AZ Ben	SWR® Big Ben 1×18"
AZ Work	SWR® WorkingMan 4×10"

Designation	Inspired by
Calif Low	Mesa/Boogie® 2×10"
Fridge	Ampeg® 8×10"
Heaven Bot	David Eden® 1×15"
Marco	Markbass® 2×10"

5.3 List of Microphones (available through Wall of Sound)

Designation	Inspired by
Dynamic 57	Dynamic microphone Shure™ SM57
Dynamic 421	Dynamic microphone Sennheiser™ MD421
Knightfall	Condenser microphone Blue™ Dragonfly
Condenser 87	Condenser microphone Neumann™ U87
Ribbon160	Ribbon microphone Beyerdynamic™ M160N
Ribbon121	Ribbon microphone Royer™ R121
Bass 20	Dynamic microphone Electrovoice™ RE20
Bass 5	Dynamic microphone Shure™ Beta52

5.4 Block diagram

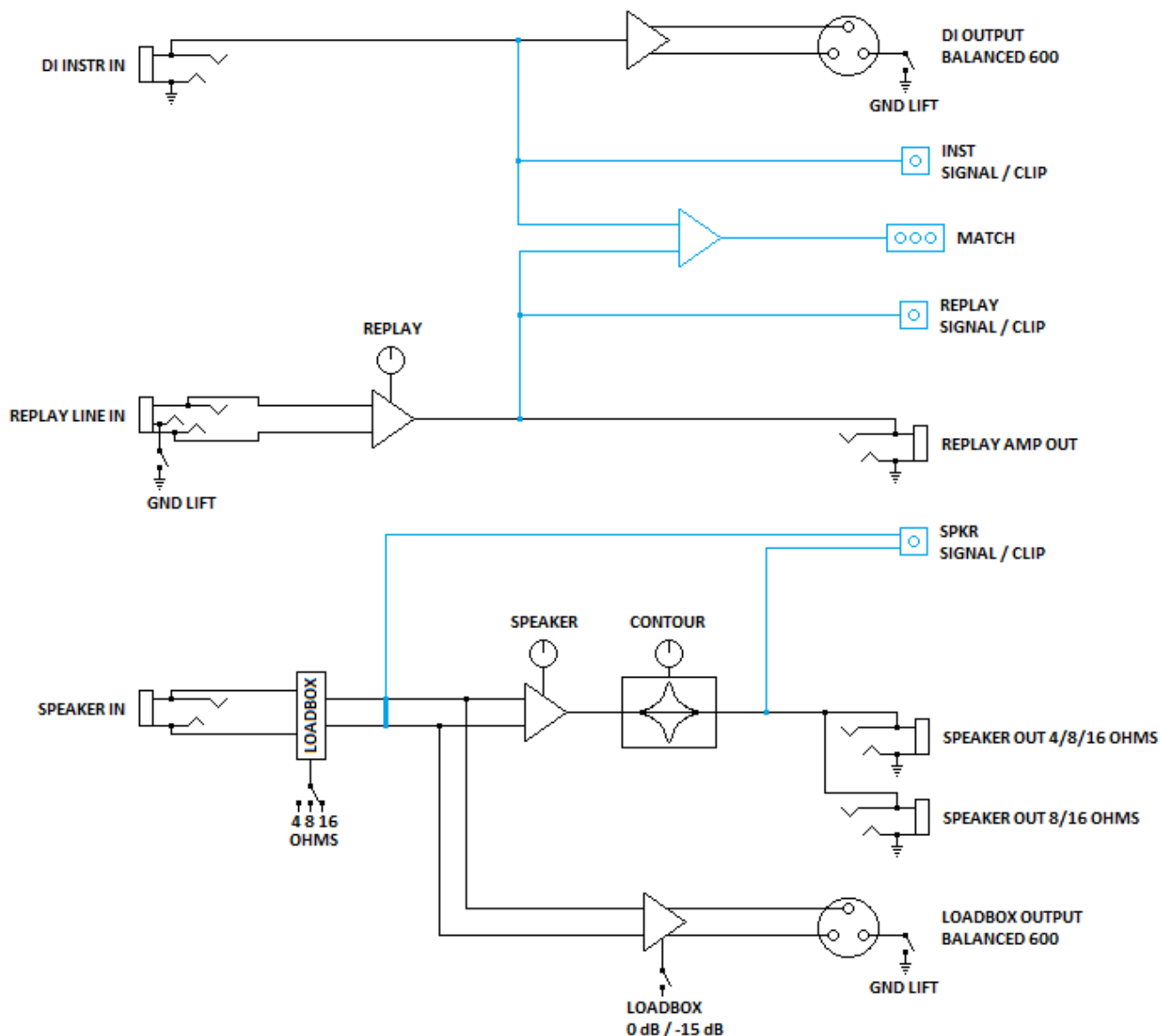

5.5 Connectors wiring

TS 6.35mm (1/4") JACK

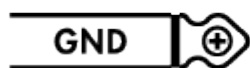

TRS 6.35mm (1/4") JACK



MALE XLR

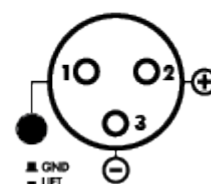

5.6 Possible speaker combinations

The Torpedo Reload features two speaker outputs, wired in parallel. There are technically equivalent. The total impedance on these two outputs can't be lower than 4 ohms. In order to respect this rule, you can refer to the following table :

Impedance - cabinet 1	Impedance - cabinet 2	Total impedance	Result
16	No cabinet	16	OK
16	16	8	OK
16	8	5.3	OK
16	4	3,2	IMPOSSIBLE
8	No cabinet	8	OK
8	16	5.3	OK
8	8	4	OK
8	4	2.7	IMPOSSIBLE
4	No cabinet	4	OK
4	16	3.2	IMPOSSIBLE
4	8	2.7	IMPOSSIBLE
4	4	2	IMPOSSIBLE

5.7 Technical Data

Designation	Characteristics
Speaker Input	Jack 6.35mm (1/4") unbalanced (TS, Tip/Sleeve) Maximum input voltage: 140 Volts AC (45 dBu) Security load: 220 Ohms / 10 Watts
Loadbox	Reactive load, nominal impedance: 4 or 8 or 16 Ohms switchable Maximum admissible power: 150W (assuming proper ventilation) Maximum temporary admissible power : 200W (assuming proper ventilation) (see this article if your amplifier is more powerful) Cooled by temperature-controlled fan
Speaker Outputs	2x Jack 6.35 mm (1/4") unbalanced (TS) Minimum load: 4 Ohms Maximum output power: <ul style="list-style-type: none"> • 25 W RMS@ 16 Ohms • 50 W RMS@ 8 Ohms • 70 W RMS@ 4 Ohms
Loadbox Output	Balanced XLR Output Impedance: 600 Ohms Ground/Lift switch Attenuation (speaker input to balanced loadbox output): 24.5 dB \\Maximum output level (balanced): 20.5 dBu Noise: under -98 dBu from 20 Hz to 20 kHz Frequency response @ -1dB: 5 Hz to 24 kHz
REPLAY™ Input	Jack 6.35mm (1/4") balanced (TRS, Tip/Ring/Sleeve) Maximum input level: 36 dBu Input impedance: 20 KOhms Ground/Lift switch
REPLAY™ Output	Jack 6.35 mm (1/4") unbalanced (TS) Impedance: 300 Ohms Gain (In to Out): 0 to -inf dB, adjustable by potentiometer Maximum output level: 19 dBu Noise: under -98 dBu from 20 Hz to 20 KHz Frequency response @ -1dB: 0 Hz to 18 kHz
DI Input	Jack 6.35 mm (1/4") unbalanced (TS, Tip/Sleeve) Impedance : 1 MOhms

Designation	Characteristics
DI Output	Balanced XLR Impedance: 600 Ohms Ground/Lift switch Gain (In to balanced Output): 6 dB Maximum In/Out level: 20 dBu Noise: under -98 dBu from 20 Hz to 20 kHz Frequency response @ -1dB: 0 Hz to 18 kHz
Thermal security	Cooled by temperature-controlled fan Thermal security: when overheating, the loadbox gets disconnected (leaving only a 220- Ohm security load) and the signal is muted.
Power supply	IEC60320 C14 power connector Input voltage: depending on your country of residence, from 100V to 230V, 50 to 60Hz Power: approx. 100W Max
Dimensions	Width: 320 mm Depth: 178 mm, 200 mm including connectors and knobs Height: 89 mm Weight: 4.5 kg

6. Technical support

Should you encounter a problem with your product or need help regarding any technical aspects, please note that Two notes Audio Engineering has developed on-line services to provide you with fast and efficient technical support, the [Two notes Help Desk](#).

Don't hesitate to browse the [Knowledgebase](#), which contains all sorts of useful informations, or [submit a ticket](#) if you have any question or need assistance with a Two notes product.

6.1 Two notes Website

On the [Two notes Audio Engineering](#) website, you will find:

- news about the company and the products (news on the homepage),
- comprehensive information about the Torpedo Reload and its many applications (FAQ),
- firmware and software updates to download (products/Torpedo Reload/downloads),
- access to the Two notes Store where you can buy new cabinets,
- the Torpedo BlendIR software (products/Torpedo Reload/downloads),
- an official forum where you can share tips and advice with other Torpedo users (forum).

The Two notes Team often visits specialized forums to help out users.

6.2 E-mail

We do not offer technical support via e-mail. Please contact us via the Help Desk at the address above.

From:

<http://wiki.two-notes.com/> - **User's manuals**

Permanent link:

http://wiki.two-notes.com/doku.php?id=torpedo_reload:torpedo_reload_user_s_manual

Last update: **2019/05/14 11:15**

